

TOTAL PERFORMANCE
VAN'S AIRCRAFT

14401 Keil Road NE, Aurora, Oregon, USA 97002

PHONE 503-678-6545 • FAX 503-678-6560 • www.vansaircraft.com • info@vansaircraft.com
Service Letters and Bulletins: www.vansaircraft.com/public/service.htm

PRODUCT/KIT NAME:

Canopy Harness

PRODUCT/KIT DESCRIPTION: WH-00126 Left Dash Mount Harness and installation instructions. Instructions included for optional LC LED Strip RED, WHITE, or RED/WHITE LED panel lighting strip installation.

Step 1: Insert a snap bushing in the C-01416-L Aft Intercostal as shown in Figure 1.

Step 2: Route the free end of the W2128 (WHT/BLK) and W2129 (BLK) wires aft along the canopy frame and down through the snap bushing in the aft intercostal as shown in Figure 1.

Loop the end of the wires through the loop in the safety wire and wrap with a small amount of tape to keep the total diameter as small as possible.

Step 3: Gently pull the safety wire from the aft end while feeding the wires through the fwd wire routing hole in the canopy frame, until they exit out of the oval wire routing hole at the back of the canopy frame. See Page 61-03 Figure 2.

Use temporary ties to anchor the wires along the flange of the canopy frame.

Step 4: Adjust all wires to remove slack and install a few permanent plastic tie wraps to prevent the wires from sliding side to side.

Step 5: Cut the two black fan wires, the W 2017 (BLK), and the W2129 (BLK) to length so that the two wires traveling from each side can be twisted together and then all 4 joined with a single butt splice connector as shown in Figure 2.

Step 6: Trim the excess length from the L2131 (YEL/GRN) and L2132 (YEL/PRP) Lighting wires and connect each to the appropriate wire for the LED lighting strip as shown in Figure 2.

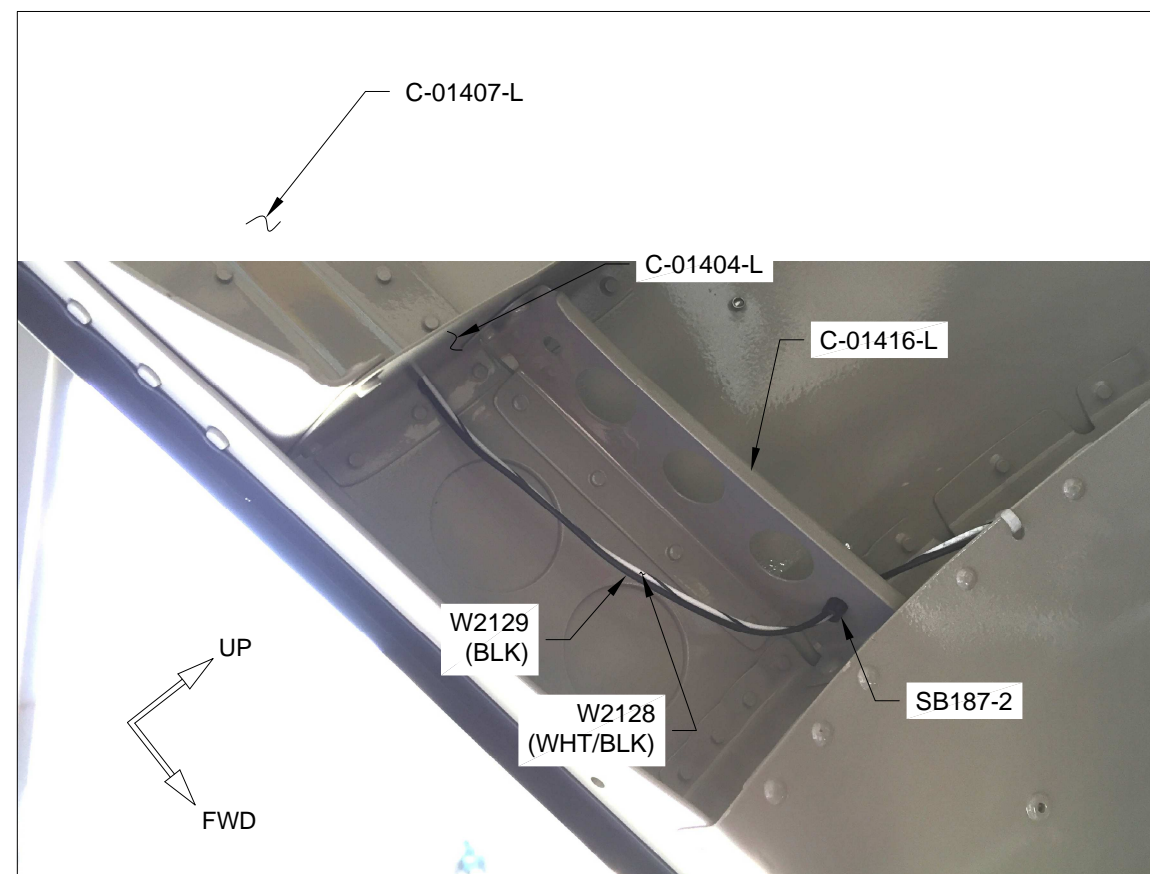

FIGURE 1: WIRE ROUTE

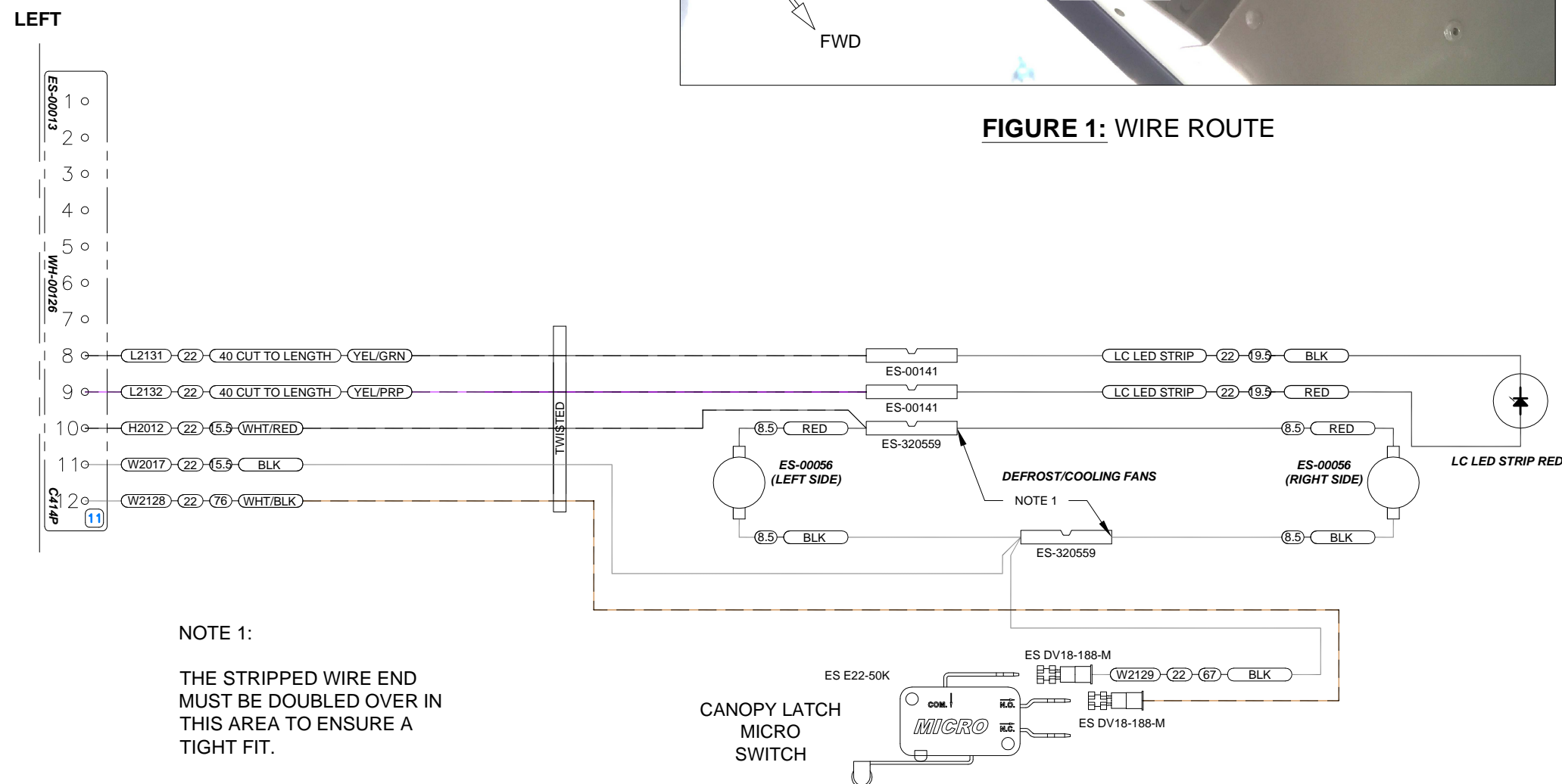
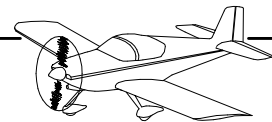

FIGURE 2: GENERIC CANOPY WIRE DIAGRAM



Step 1: Close and latch the canopy from the inside.

Move the top of the ES E22-50K Switch aft against the latch pin using light pressure and tighten the screws to lock it in position.

Use an ohm meter or continuity tester to check between the two forward terminals. Confirm that the switch changes state from continuity/zero ohms when latched to no continuity/infinite resistance when the canopy latch handle is moved to the open position.

Step 2: Trim the excess length from the W2128 (WHT/BLK) and W2129 (BLK) Canopy Latch Switch wires so that 2 3/4 in. [69.9 mm] protrudes out of the hole beside the switch.

NOTE: See Section 5.21 for information on electrical connections.

Step 3: Install the spade connectors on the canopy latch switch wires as shown in Figure 1. Connect the wires to the canopy latch switch as depicted.

Step 4: Apply a small amount of clear silicone sealant to the wire routing holes in the canopy frame at each end of the wire run to prevent wire movement/chaffing. See Figure 1.

Step 5: After completing all wire installation, install a plastic tie wrap at each tie hole location. Trim the excess "tails" off of the plastic tie wraps and rotate so that the stub is less visible as shown in Figure 2.

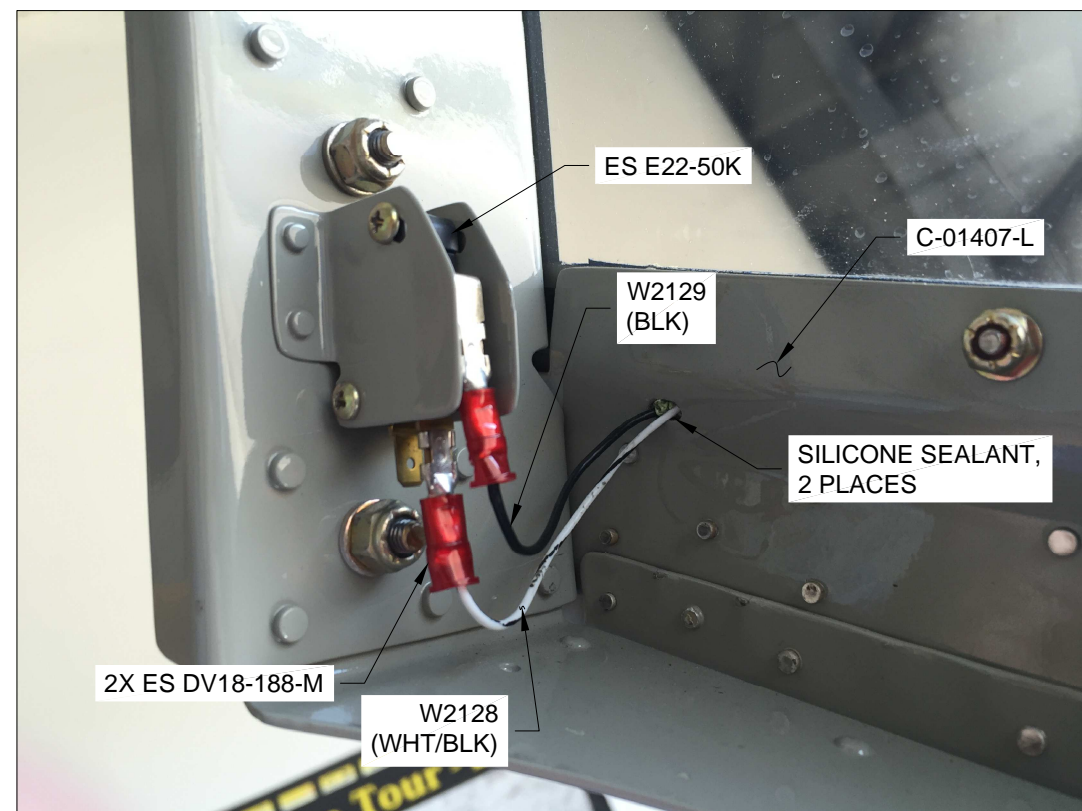

FIGURE 1: CONNECTING TO SWITCH

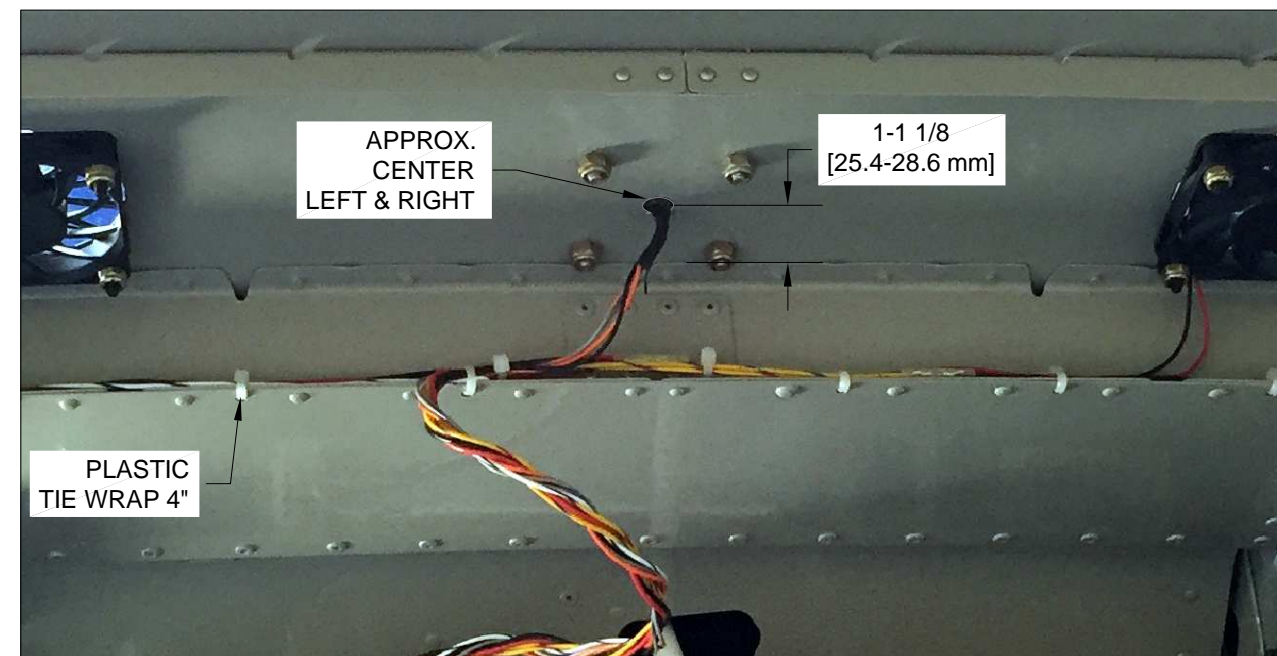

FIGURE 2: GPS ANTENNA LOCATION
DYNON SHOWN

NOTE: Antennas mounted on the glare shield are for VFR use only.

NOTE: The following steps in this section are marked (Dynom) or (Garmin). Follow those steps that apply to your installation.

Step 6 (Dynom): Use the manufacturers instructions, recommended hardware, and mounting dimensions to mount the antenna on the center right of the upper surface of the canopy skin. Take care not to locate any fasteners or protrusions so far aft that they interfere with the F-01467B Instrument Panel Flange Doubler. See Figure 2 and Page 61-06 Figure 2 for approximate location.

Optional - The antenna can be painted flat black after light scuffing with a Scotchbrite™ pad to reduce reflection in the canopy with no degradation in reception. Avoid paints that contain any materials (such as metal flakes) that may inhibit the GPS signal.

NOTE: See Section 5.21 Electrical for detailed information on pin installation.

Step 7 (Dynom): Unplug the ES-00013 harness connector of the WH-00126 Canopy Wiring Harness from the ES-00012 connector. Wrap the four wires of the Dynom GPS Antenna individually around the twisted portion of the harness.

Trim the GPS wires with 1/2 in. [12.7 mm] extra length to attach pins for insertion into the connector.

Install an ES-00005 Molex Pin on each wire and insert into the appropriate socket positions as shown on the RV-14 Common Fuselage Harness drawing (available for download on the Van's Aircraft page).

Reconnect the harness.

NOTE: Antennas mounted on the glare shield are for VFR use only.

Step 1 (Garmin): Use the manufacturers instructions and mounting dimensions to mount the GI260 Garmin AOA Indicator on the C-01418 Canopy Skin. The indicator should be visible from both seats and clear of the canopy and instrument panel as shown in Figure 1.

Step 2 (Garmin): Use the manufacturers instructions and mounting dimensions to mount the GPS Receiver Antenna on the center right of the upper surface of the canopy skin. Take care to locate any fasteners or protrusions to avoid interference with the F-01467B Instrument Panel Flange Doubler. See Figure 2 & 3 for approximate location.

Optional - The antenna can be painted flat black after light scuffing with a Scotchbrite™ pad to reduce reflection in the canopy with no degradation in reception. Avoid paints that contain any materials (such as metal flakes) that may inhibit the GPS signal.

NOTE: See Section 5.21 Electrical for detailed information on pin installation.

Step 3 (Garmin): Unplug the ES-00013 Connector of the WH-00126 Canopy Wiring Harness from the ES-00012 Connector.

Wrap the wires of the GPS Antenna and AOA Indicator individually around the twisted portion of the harness.

Trim the wires to length with an extra 1/2 in. [12.7 mm] to allow attaching pins and inserting into the connector.

Install an ES-00005 Molex Pin on each wire and insert into the appropriate socket positions as shown on the RV-14 Common Fuselage Harness drawing (available for download on the Van's Aircraft page).

Reconnect the harness plug.

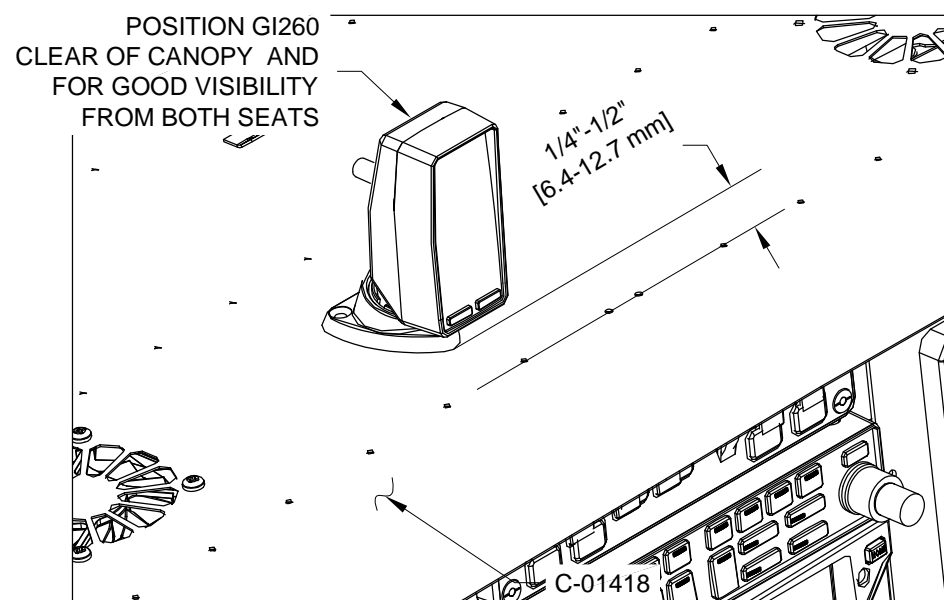

FIGURE 1: AOA POSITION
GARMIN TOP VIEW

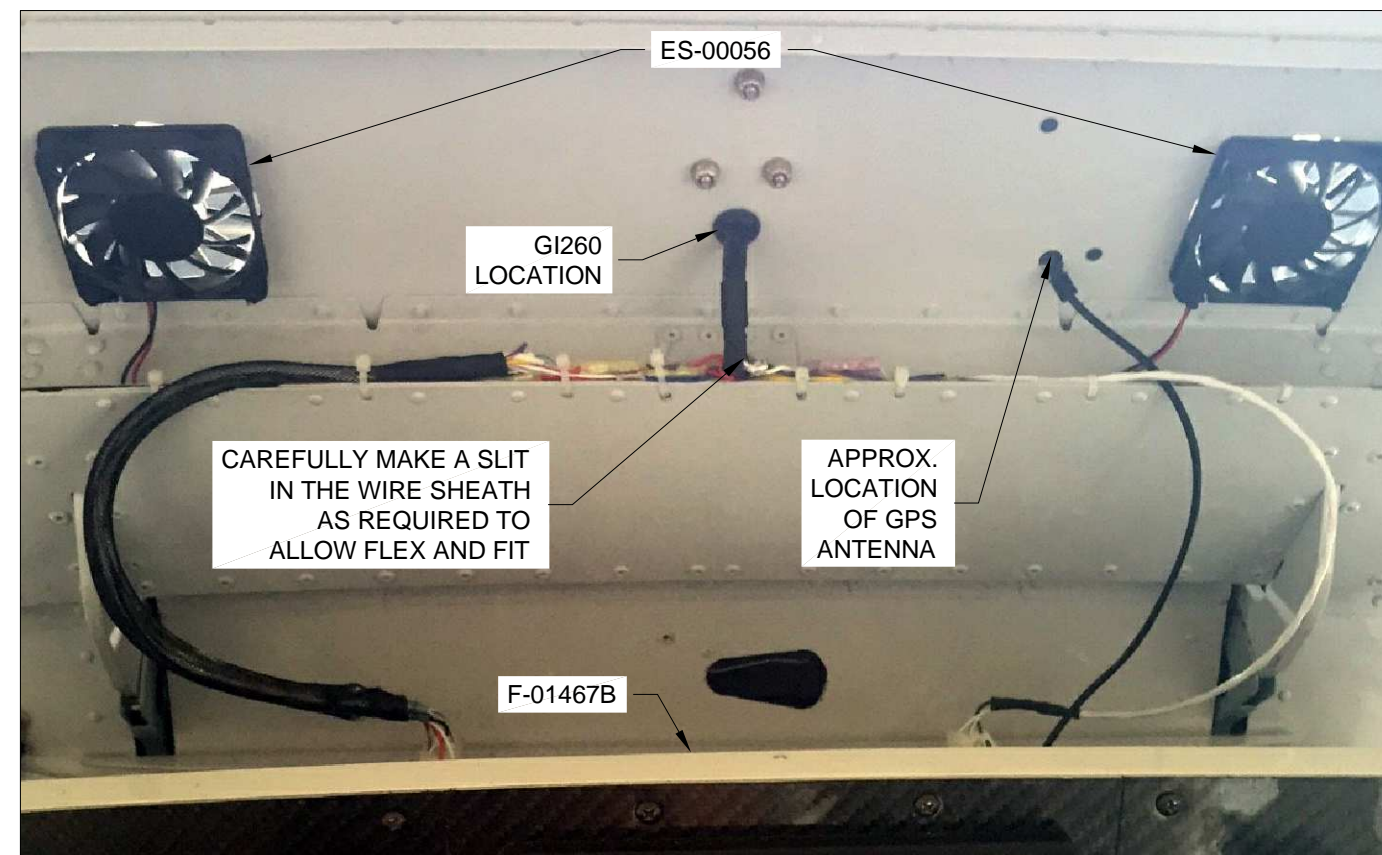

FIGURE 2: AOA/GPS ANTENNA INSTALLATION
GARMIN BOTTOM VIEW

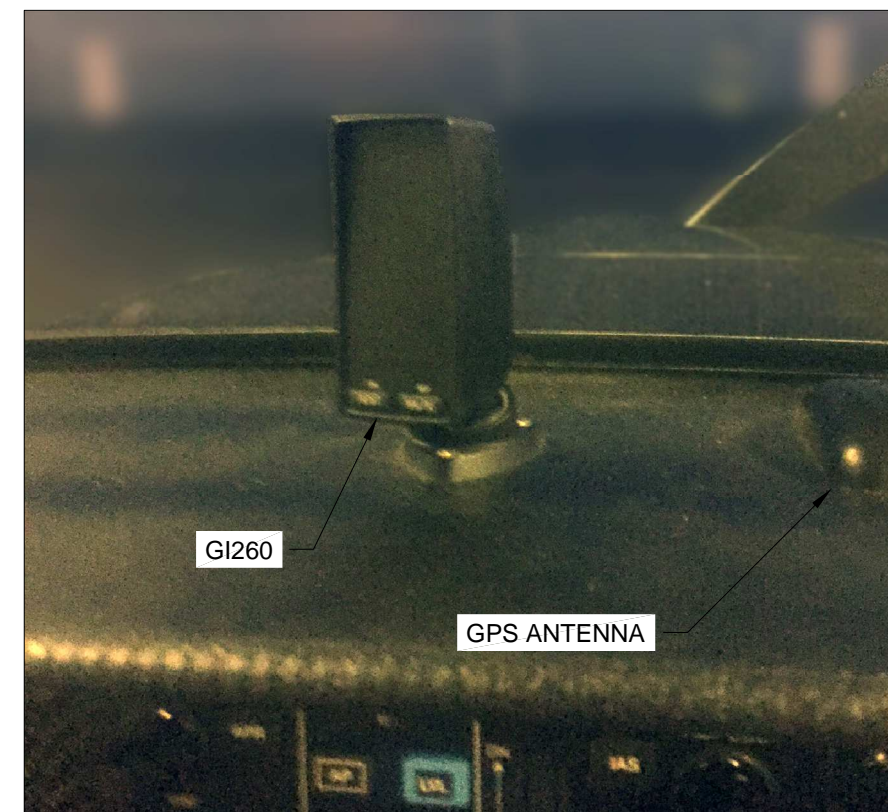

FIGURE 3: AOA/GPS ANTENNA LOCATION
GARMIN TOP VIEW